



*moving forward in every field*

LANGUAGE • EN

# SEATS

## ▶▶ ACCESSORIES

Catalogue - First published 2007

[www.bepcoparts.com](http://www.bepcoparts.com)

Member of **TVH** 

# ABOUT BEPCO

---

Bepco Group is a worldwide leading supplier of parts and accessories for agricultural tractors and machinery.

With over 360 employees Bepco Group has subsidiaries in Belgium, Netherlands, France, Germany, Spain and UK and is also present in Australia, New Zealand, South Africa and Brazil.

Bepco Group is a truly global company with customers in over 100 countries worldwide and sales outside Europe contributing to over a third of revenues.

We offer our network of distributors and dealers :

- ▶▶ Original Equipment Supplier and other industry leading brands
- ▶▶ More than 20,000 m<sup>2</sup> of warehousing
- ▶▶ More than 80,000 stock items
- ▶▶ Technological knowledge from industry experts
- ▶▶ Same day shipment, next day delivery in many markets



Bepco Group is also a member of TVH, the all-round supplier of quality parts and accessories for material handling, industrial vehicles and agricultural equipment.

**Seats intermediate range**



**61/830-322**

- Synthetic black leather
- Adjustable mechanical suspension (travel 80mm)
- Slide rails (160mm)
- Weight adjustment (max 136 Kg)
- Flat mounting plate



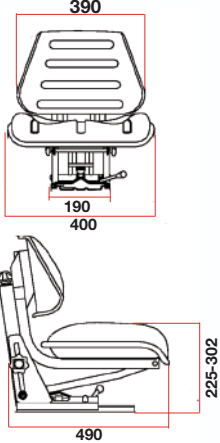



**61/830-324**

- Synthetic black leather
- Adjustable mechanical suspension (travel 80mm)
- Slide rails (travel 150mm)
- Weight adjustment (max 150 Kg)
- Angle mounting plate
- With seat belts

- See 61/830-337  
(Synthetic yellow leather)(John Deere)



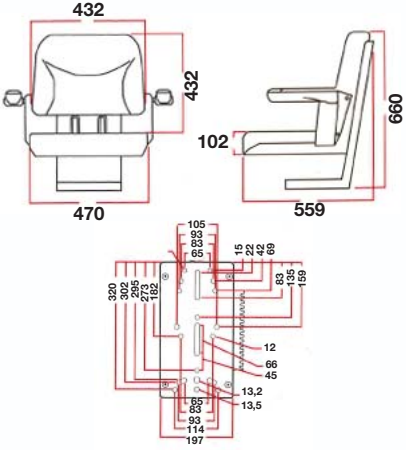





**61/830-332**

- Synthetic black leather
- Adjustable mechanical suspension (travel 100mm)
- Slide rails (travel 145mm)
- Weight adjustment (max 120 Kg)
- Flat mounting plate

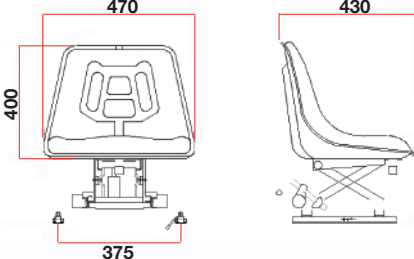

**Seats intermediate range**



**61/830-321**

- Blue cloth
- Adjustable mechanical suspension (travel 20mm)
- Slide rails (travel 170mm)
- Weight adjustment (max 120Kg)
- Flat mounting plate

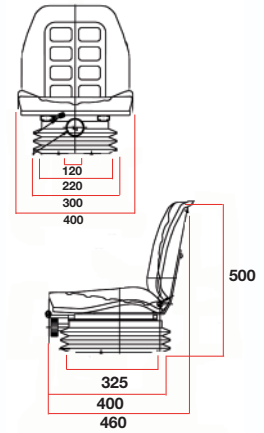

**61/830-323**

- Synthetic black leather
- Adjustable mechanical suspension (travel 20mm)
- Slide rails (travel 170mm)
- Weight adjustment (max 120Kg)
- Flat mounting plate

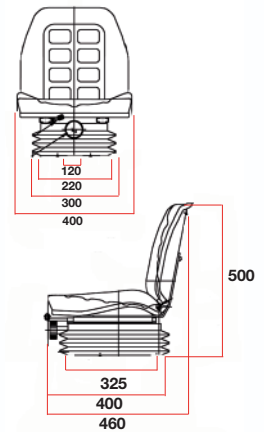



**Seats for vineyard tractors**



**61/830-325**

- Synthetic black leather
- Flat mounting plate



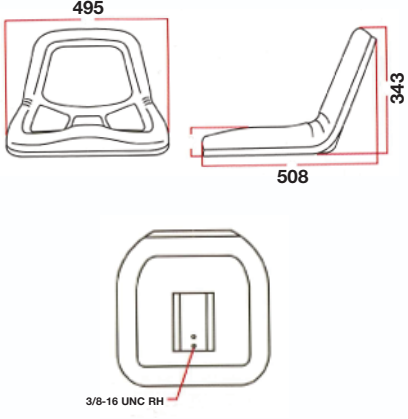







**61/830-331**

- Synthetic blue leather
- Adjustable mechanical suspension (travel 100mm)
- Weight adjustment (max 120 Kg)
- Flat mounting plate
- Ford (New Holland)

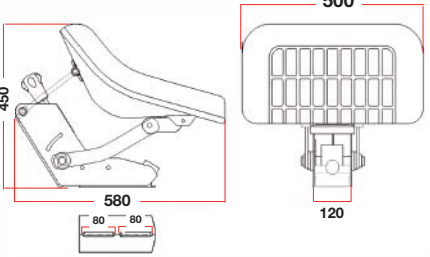



**Seats for tractors park and garden**



**61/830-326**

- Synthetic yellow leather
- Flat mounting plate
- John Deere



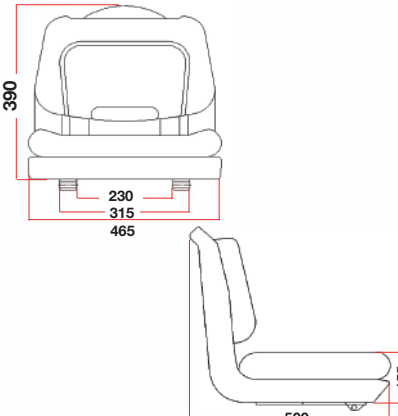





**61/830-328**

- Synthetic yellow leather
- Adjustable mechanical suspension (travel 20mm)
- Slide rails (travel 170mm)
- Weight adjustment (max 120Kg)
- Flat mounting plate
- John Deere

61/830-327 Pan

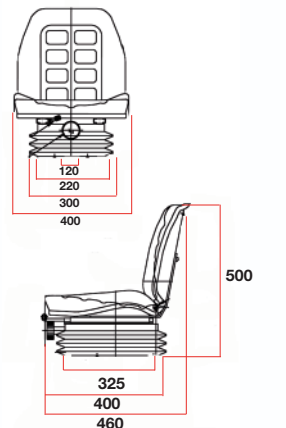









**61/830-329**

- Synthetic yellow leather
- Flat mounting plate
- John Deere

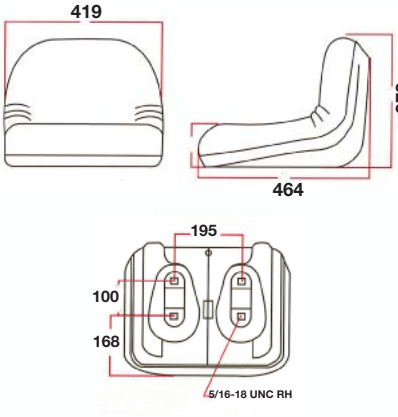



**Seats for tractors park and garden**

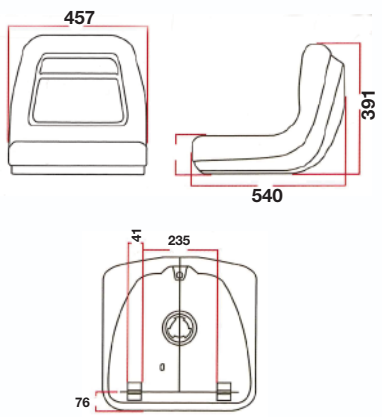

**61/830-330**

- Synthetic yellow leather
- Flat mounting plate
- John Deere









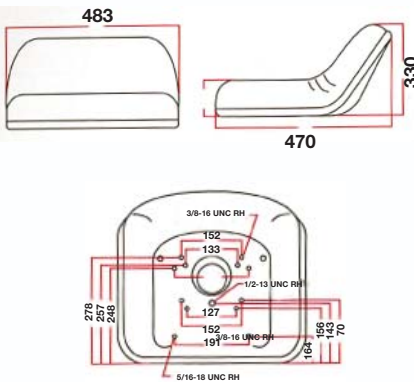

**61/830-333**

- Synthetic black leather
- Flat mounting plate
- Case-IH









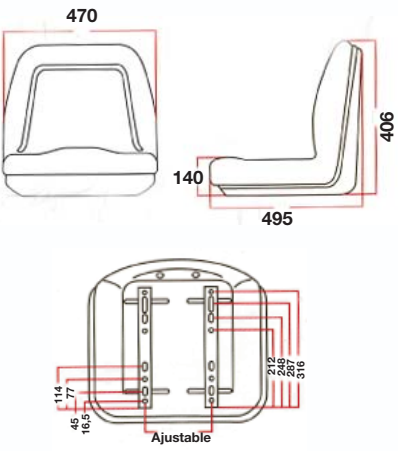

**61/830-334**

- Synthetic black leather
- Flat mounting plate
- Case-IH











## Index













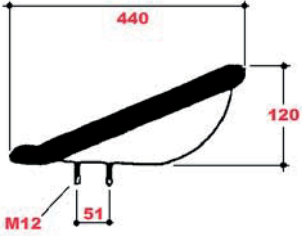



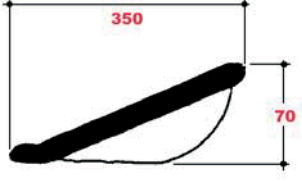

Pan seats	1-2
Fork-lift seats	1-3
Standard seats	1-4 ...6
Luxury seats	1-7...9
Vineyard seats	1-10...11
Seat belts	1-12
Turn table	1-12
Security plate	1-12
Heating vover	1-12
Armrests	1-13
Backrest extensions	1-13
Replacement parts	1-14
Cushions and covers (By seat type)	1-15
Cushions and covers (By tractor application)	1-16...18

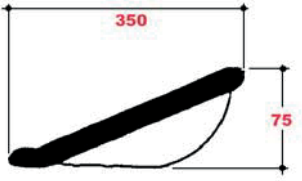
## Key

 <p>For fork-lift</p>	 <p>No suspension</p>
 <p>For old timer</p>	 <p>Mechanical suspension</p>
 <p>For standard range</p>	 <p>Pneumatic suspension</p>
 <p>For high range</p>	 <p>Turn table</p>
 <p>For vineyard</p>	

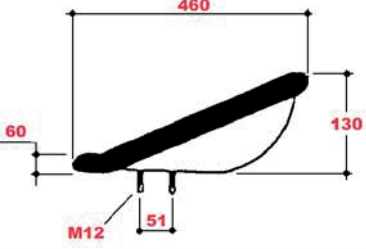

**Pan seats**

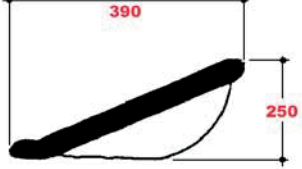
	<p><b>61/830-20</b></p> <ul style="list-style-type: none"> <li>- Black covering</li> <li>- Fitting by 2 bolts</li> </ul>  	
	<p><b>61/830-21</b></p> <ul style="list-style-type: none"> <li>- Iron covering</li> <li>- Central fitting</li> </ul>  	
	<p><b>61/830-22</b></p> <ul style="list-style-type: none"> <li>- Red covering</li> <li>- Central fitting</li> </ul>  	
	<p><b>61/830-640</b></p> <ul style="list-style-type: none"> <li>- Synthetic black leather covering</li> <li>- Comfortable contour support</li> </ul>  	
	<p><b>61/830-611</b></p> <ul style="list-style-type: none"> <li>- Black iron covering</li> <li>- Central fitting</li> </ul>  	



**Fork-lift seats**

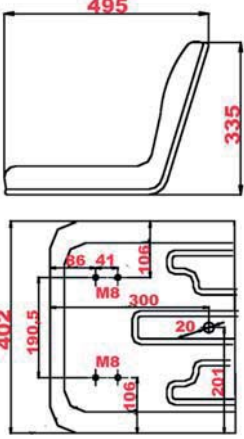

**61/830-940**

- Synthetic black leather
- Fitting support included
- Flat mounting plate









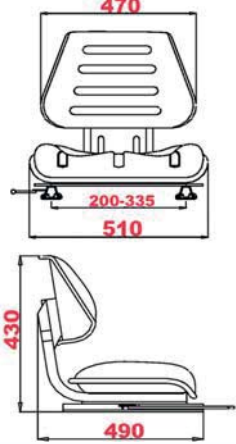

**61/830-881**

- Synthetic black leather
- Slide rails (70 mm)
- Flat mounting plate









**61/830-882**

- Synthetic black leather
- Mechanical suspension (travel 40 mm)
- Slide rails (210mm)
- Backrest tilt adj. +3°/-12°
- Weight adjustment (60-120 Kgs)
- Flat mounting plate
- Seat belt fixation points

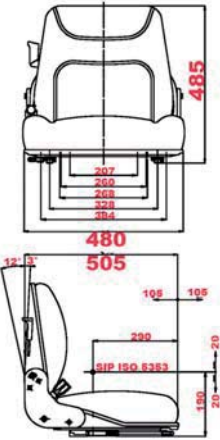
**Options**

61/834-9 Fold-up armrests



**Seats intermediate range**



**61/830-621**

- Upholstered covering
- Adjustable mechanical suspension (travel 90mm)

61/830-622 Pan











**61/830-801**

- Synthetic blue leather
- Adjustable mechanical suspension (5 positions - travel 80mm)
- Weight adjustment (max 120 Kg)
- Slide rails (120 mm)
- Flat mounting plate
- Ford (New Holland)

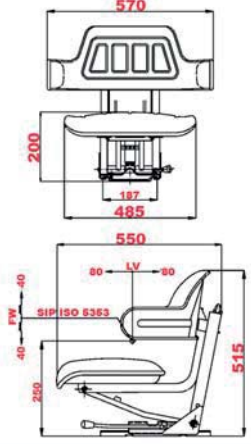







**61/830-825**

- Synthetic yellow leather
- Adjustable mechanical suspension (5 positions - travel 80mm)
- Weight adjustment (max 120 Kg)
- Slide rails (120 mm)
- Angle mounting plate
- John Deere

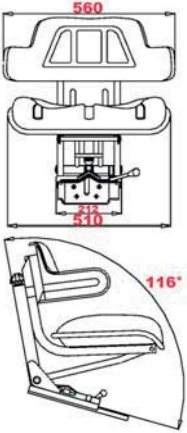

**Standard seats**



**61/830-934**

- Synthetic black leather
- Mechanical suspension (travel 80 mm)
- Slide rails (120 mm)
- Height adjustment (60 mm)
- Weight adjustment (max 120 Kg)
- Flat mounting plate

**Options**

61/834-4 Fold-up armrests

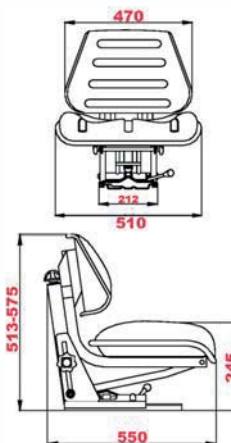

**61/830-872**

- Black cloth
- Mechanical suspension (travel 80 mm)
- Slide rails (160 mm)
- Height adjustment (60 mm)
- Weight adjustment (max 120 Kg)
- Flat mounting plate
- Seat belt fixation points
- With fold-up armrests

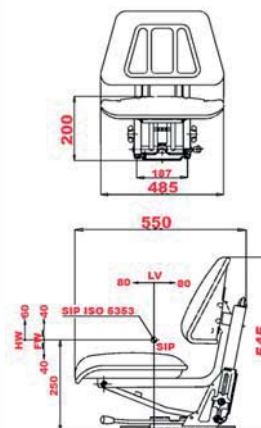

**61/830-935**

- Synthetic black leather
- Mechanical suspension (travel 80 mm)
- Slide rails (120 mm)
- Height adjustment (60 mm)
- Weight adjustment (max 120 Kg)
- Flat mounting plate

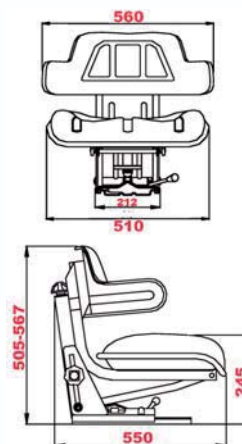

**Standard seats**



**61/830-845**

- Synthetic black leather
- Mechanical suspension (travel 80 mm)
- Slide rails (160 mm)
- Adjustable plate angle *from 0° to 30°* (6 positions)
- Weight adjustment (max 120 Kg)

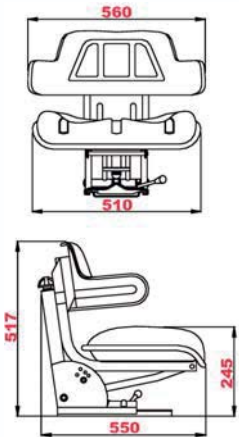

**61/830-865**

- Synthetic black leather
- Mechanical suspension (travel 80 mm)
- Slide rails (120 mm)
- Adjustable plate angle *from 0° to 30°* (6 positions)
- Weight adjustment (max 120 Kg)

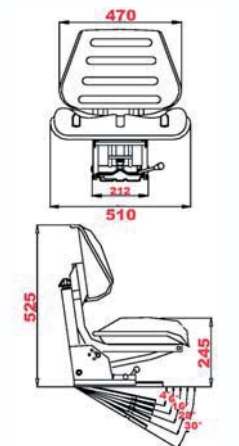

**61/830-941**

- Synthetic black leather
- Foldable
- Mechanical suspension (travel 80 mm)
- Slide rails (160 mm)
- Height adjustment (60 mm)
- Adjustable plate angle *from 0° to 22°*
- Weight adjustment (max 120 Kg)

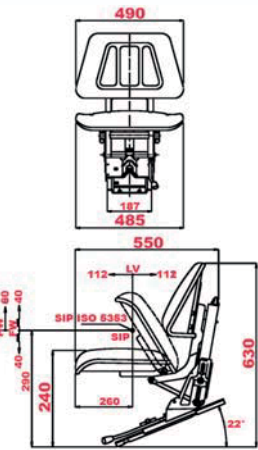

**Luxury seats**



**61/830-936**  
Synthetic black leather

**61/830-937**  
Black cloth

- Black cloth
- Mechanical suspension (travel 110 mm)
- Slide rails (210 mm)
- SIP adjustment 40 mm
- Suspension travel reducer 80mm
- Foldable backrest with 22° adjustment
- Weight adjustment (max 130 Kgs)
- Adjustable lumbar support
- Flat mounting plate
- Narrow mounting plate : 225 mm
- Seat belt fixation points

**Options**

61/834-10 Fold-up armrests  
61/836-6 Backrest extension (synthetic)  
61/836-7 Backrest extension (cloth)



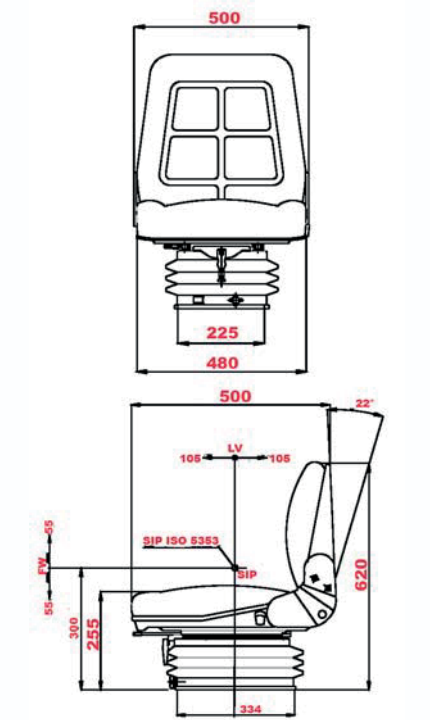





**61/830-931**

- Black cloth
- Adjustable pneumatic suspension (travel 80 mm)
- Height adjustment(40 mm)
- Slide rails (210 mm)
- Foldable backrest with 22° adjustment
- Weight adjustment (max130 kg)
- Flat mounting plate
- Narrow mounting plate : 225 mm
- Seat belt fixation points

**Options**

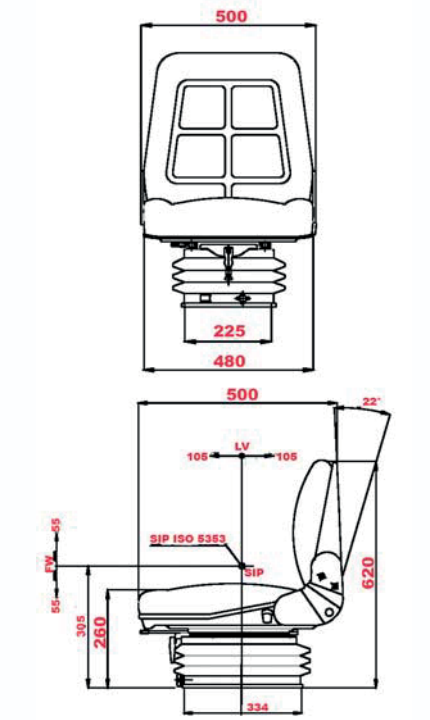
61/834-10 Fold-up armrests  
61/836-7 Backrest extension (cloth)







**Luxury seats**

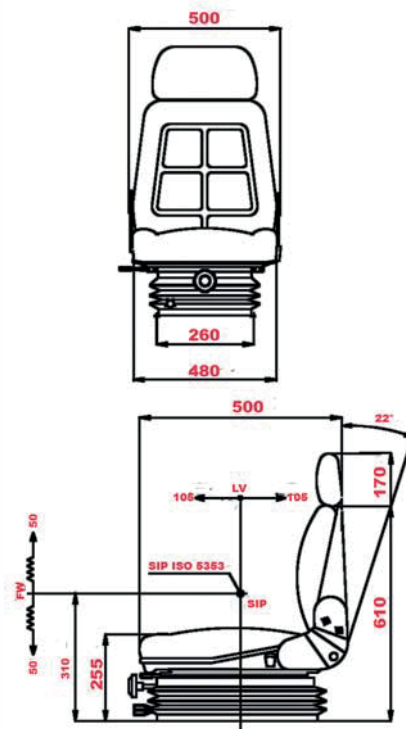

**61/830-972**

- Black cloth
- Backrest extension
- Armrest
- Adjustable mechanical suspension (travel 100 mm)
- SIP adjustment 35 mm
- Stroke reducer 70mm
- Slide rails (210 mm)
- Foldable backrest with 22° adjustment
- Weight adjustment (max 150 kg)
- Adjustable lumbar support
- Flat mounting plate
- Seat belt fixation points



**61/830-973**

- Black cloth
- Backrest extension
- Armrest
- Adjustable pneumatic suspension (travel 100mm)
- Slide rails (210 mm)
- Foldable backrest with 22° adjustment
- Weight adjustment (max 130 kg)
- Adjustable lumbar support
- Flat mounting plate
- Turn table 5 positions (0°-12°-20°-45°-180°)
- Seat belt fixation points

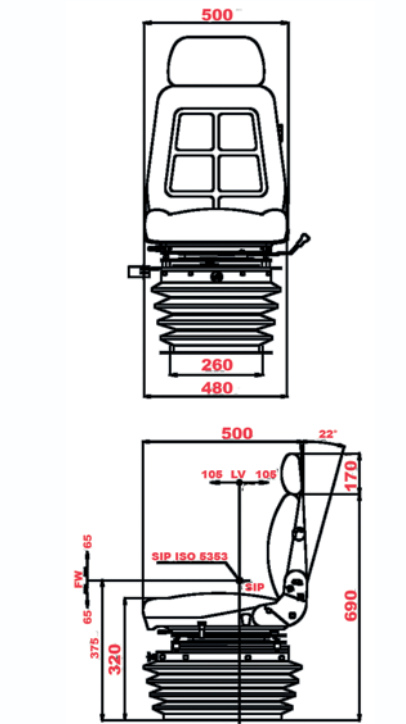

**Luxury seats**

**61/830-974**



- Grey velour cloth
- Adjustable backrest extension
- Adjustable Armrest
- Mechanical suspension (travel 100 mm)
- SIP adjustment 35 mm
- Stroke reducer 70mm
- Weight adjustment (max 150Kg)
- Slide rails (190 mm)
- Foldable backrest with 32° adjustment
- Adjustable lumbar support
- Document pouch
- Flat mounting plate
- Seat belt fixation points
- Turn table 6°-12°-20°

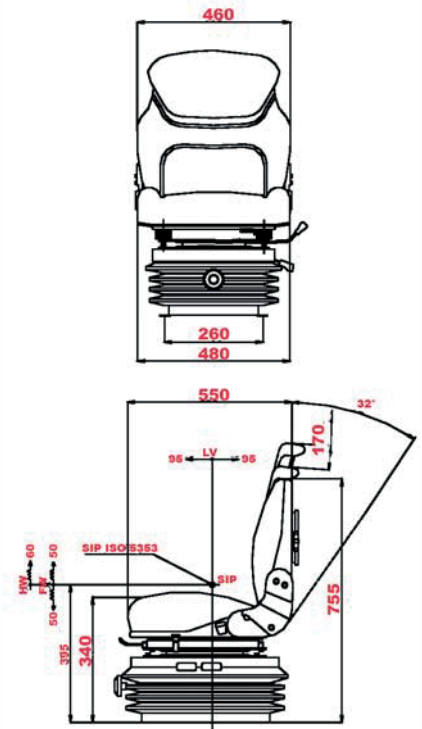

**61/830-975**



- Grey velour cloth
- Adjustable backrest extension
- Adjustable Armrest
- pneumatic suspension(travel 110 mm)
- Height adjustment(85 mm)
- Weight adjustment (max 150Kg)
- Slide rails (190 mm)
- Foldable backrest 32° / repliable
- Adjustable lumbar support
- Document pouch
- Flat mounting plate
- Seat belt fixation points
- Turn table 6°-12°-20°

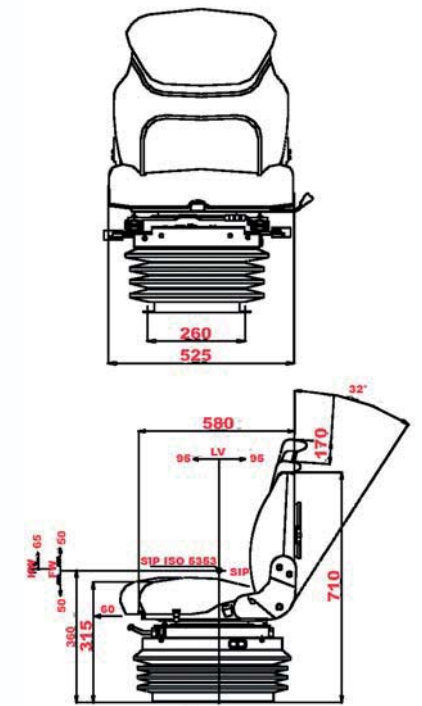





**Seats for vineyard tractors**

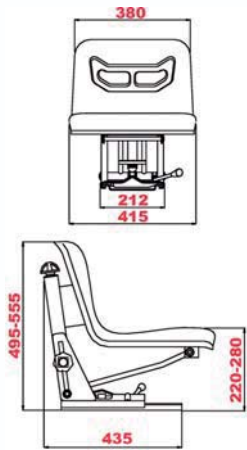

**61/830-930**

- Synthetic black leather
- Mechanical suspension (travel 80mm)
- Weight adjustment (max 120 Kg)
- Slide rails (120mm)
- Height adjustment (60 mm)
- Flat mounting plate









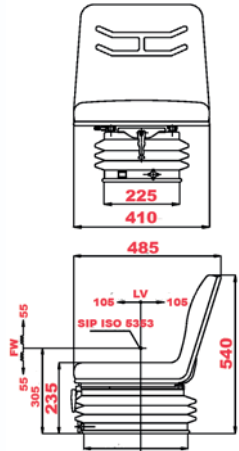

**61/830-992**

- Synthetic black leather
- Mechanical suspension (travel 110 mm)
- SIP adjustment 40 mm
- Stroke reducer 80mm
- Weight adjustment (max 130 Kg)
- Slide rails (210 mm)
- Flat mounting plate
- Seat belt fixation points





**61/830-995**

- Black cloth
- pneumatic suspension (travel 110 mm)
- Height adjustment (40 mm)
- Weight adjustment (max 130 Kg)
- Slide rails (210 mm)
- Flat mounting plate
- Seat belt fixation points

**Options**

61/831-39 Cuvette de remplacement







**Seats for vineyard tractors**



**61/830-55**

- Synthetic yellow leather
- Mechanical suspension (travel 80mm)
- Slide rail (120mm)
- Weight adjustment (max 120 Kg)
- Angle mounting plate (16°)

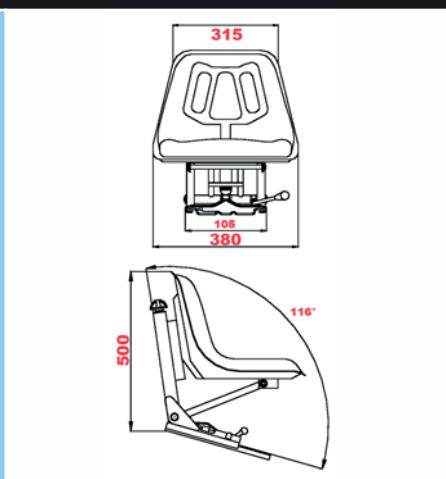

**KLEPP**

**61/830-160**

- Synthetic black leather
- Mechanical suspension (travel 55mm)
- Slide rail (290mm)
- Weight adjustment (max 120 Kg)
- Angle mounting plate (0°-11°-20°)

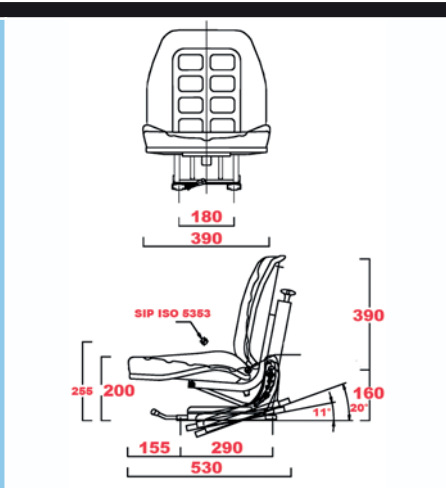

**KLEPP**

**61/830-202**

- Synthetic black leather
- Pneumatic suspension (travel 40mm)
- Slide rail (200mm)
- Weight adjustment (max 120 Kg)
- Flat mounting plate

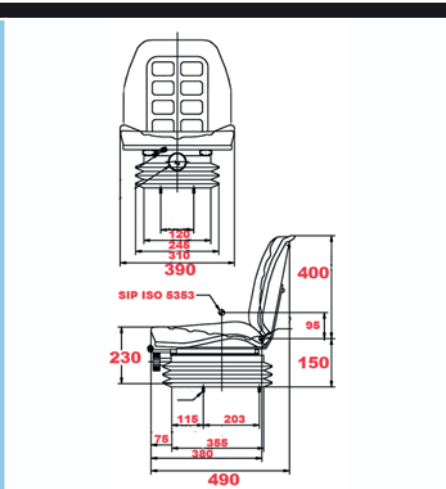

**Seat belts**



Ref.	Fig.	Description
61/828-1	1	Retractable
61/828-2	2	Fixed

**Turn table**



Ref.	Description
61/835-6	Turn table 5 positions 0°-20°-45°-90°-180°
61/835-7	Turn table 2 positions 0°-180°

**Safety plate**

Ref.	Description
61/833-6	Safety plate



**Heating cover**



Ref.	Description
61/831-23	Heating cover 12V

**Armrest**

Ref.	Illustration	Applications
61/834-9		61/830-882
61/834-4		61/830-934
61/834-10		61/830-936, 61/830-937, 61/830-931, 61/830-972, 61/830-973
61/834-12		61/830-974, 61/830-975

**Backrest extensions**

Ref.	Illustration	Applications
61/836-6 Synthetic leather		61/830-936

Ref.	Illustration	Applications
61/836-7 Black cloth		61/830-937, 61/830-931

**Replacement parts**



Ref.	1	2	3	4	5	6
	Spring	Shock absorber	Horizontal shock absorber	Compressor	Airbag kit	Clips
Mechanical suspension Classico E 61/830-801, 61/830-825, 61/830-934, 61/830-935, 61/830-845, 61/830-865, 61/830-881	<b>61/837-12</b>	<b>61/837-13</b>				
Mechanical suspension Classico S 61/830-872	<b>61/837-14</b>	<b>61/837-10</b>				
Mechanical suspension SM80X 61/830-936 - 61/830-937- 61/830-992	<b>61/837-20</b>	<b>61/837-19</b>				
Mechanical suspension M100X 61/830-933 - 61/830-938	<b>61/837-18</b>	<b>61/837-16</b> (-> 22/03/2006) ou <b>61/837-17</b> (22/03/2006 ->)				
Pneumatic suspension SA80 61/830-931 - 61/830-995		<b>61/837-22</b>				<b>61/837-28</b>
Pneumatic suspension A100D 61/830-932		<b>61/837-23</b>		<b>61/837-21</b>	<b>61/837-27</b>	
Pneumatic suspension A140D 61/830-939	<b>61/837-25</b>	<b>61/837-23</b> + <b>61/837-26</b> variables shocks	<b>61/837-24</b>			

Ref.	7	8	9
	Weight adj. handle	Roller kit	Operating switch
Mechanical suspension M100X 61/830-933 - 61/830-938	<b>61/833-3</b>	<b>61/837-29</b>	
Pneumatic suspension SA80 61/830-931 - 61/830-995			<b>61/837-31</b>
Pneumatic suspension A100D 61/830-932		<b>61/837-30</b>	
Pneumatic suspension A140D 61/830-939			

**Other replacement parts available on request.  
Please contact us.**

### Cushions and cover (By seat type)

Ref.		Seat	Fig	Dimensions
<b>Cushion with backrest for seat pan</b>				
61/831-4	Set		1	420x380x200
61/831-40	Set		2	410x380x260
61/831-41	Set		3	410x380x260
<b>Cushion for seat Bostrom</b>				
61/831-49	Set		4	450x370x270
<b>Cushion for seat Grammer</b>				
61/831-5	Set		5 + 6	
61/831-8	Cushion	DS/D2	5	440x320x60
61/832-2	Backrest		6	450x360x80
61/831-6	Set		7 + 8	
61/831-9	Cushion	DS/D3	7	520x380x130
61/832-3	Backrest		8	450x360x80
61/831-7	Base cover	DS85/90	9	400x390x100
61/832-4	Backrest cover		10	400x90x400
61/831-3	Cover	DS20/B	11	500x380x280
61/831-18	Set		12 + 13	
61/831-19	Cushion	DS20/LH2	12	430x370x90
61/831-20	Backrest		13	690x380x300
61/831-36	Set	DS50	14	510x440x200
<b>Cushion for seat Klepp</b>				
61/832-8	Backrest cover	Elastomat 1050 Synthetic	15	430x320x60
61/831-42	Base cover		16	470x370x80
61/832-9	Backrest cover	Elastomat 1050 Cloth	15	430x320x60
61/831-43	Base cover		16	470x370x80
<b>Cushion for seat Sifra</b>				
61/832-10	Backrest	Serie F	17	500x320x65
61/832-11	Backrest cover		18	440x380x70
61/831-44	Cushion	Serie B		19
61/831-45	Base cover		20	420x390x70
61/832-12	Backrest cover	Serie P, LP, PE	21	440x260x45
61/831-47	Cushion		22	470x350x70
61/832-15	Backrest cover	Serie GL12	23	430x550x140
61/831-48	Base cover		24	470x500x80



**Cushions et covers (By application)**

Ref.		Applications	Fig	Dimensions
<b>Case-IH</b>				
61/831-18	Set	Seat Grammer DS20/LH2	1 + 2	
61/831-19	Cushion		1	430x370x90
61/831-20	Backrest		2	690x380x300
61/831-51	Set	Old models	3 + 4 + 5	
61/832-16	Backrest		3	410x350x30
61/831-52	Cushion		4	700x30x180
61/832-17	Backrest		5	400x140x60
61/831-54	Cover		6	470x450x300
<b>Claas - Renault DMA</b>				
61/831-46	Cushion	SIFRA B12	7	420x390x70
61/832-12	Backrest cover		8	700x380x50
61/831-24	Cushion		9	410x340x110
61/831-25	Backrest		10	360x195x35
61/831-26	Backrest		11	355x220x60
61/831-27	Cushion		12	340x310x85
61/831-28	Cushion		13	400x380x90
<b>Clayson</b>				
<i>Voir Sperry New Holland</i>				
<b>David Brown</b>				
61/831-2	Set	K947556/7	14 + 15	
61/831-34	Cushion		14	470x370x100
61/832-7	Backrest		15	410x40x105
61/831-3	Cover	K964819 Grammer	16	500x380x280
<b>Deutz (KHD Deutz-Fahr)</b>				
61/831-4	Set	Serie 05	17	420x380x200
61/831-5	Set	Serie 06 Grammer DS/D2	18 + 19	
61/831-8	Cushion		18	440x320x60
61/832-2	Backrest		19	450x360x80
61/831-6	Set	Series 06, 07 Grammer DS/D3	20 + 21	
61/831-9	Cushion		20	520x380x130
61/832-3	Backrest		21	490x400x120
61/831-7	Cushion cover	Grammer DS85/90	22	400x380x100
61/832-4	Backrest cover		23	400x360x110
<b>Fendt</b>				
61/831-36	Set	Grammer DS50	24	510x440x200
61/831-7	Base cover	Grammer DS85, DS90	22	400x380x100
61/832-4	Backrest cover		23	400x360x110



### Cushions et covers (By application)

Ref.		Applications	Fig	Dimensions
<b>Fiat (New Holland)</b>				
61/831-16	Cover	400, 450, 500, 550, 580, 600, 800, 900	1	510x370x290
61/831-57	Cushion	400, 450, 500, 600, 650, 750, 800, 900	2	480x330x30
61/832-18	Backrest		3	300x30x190
61/831-58	Set	450, 480, 540, 640, 850, 1000, 1300	4 + 5	
61/831-59	Cushion		4	460x340x80
61/832-19	Backrest		5	760x70x120
61/831-61	Cushion		Someca 40 -> 715	6
61/832-20	Backrest	7		430x40x140
<b>Ford (New Holland)</b>				
61/832-7	Backrest	Major, Dexta	8	410x40x105
61/831-15	Cushion		9	70x370x100
61/831-16	Backrest cover	Pan	1	510x370x290
61/831-17	Backrest cover		10	430x300x300
61/831-18	Set	Grammer	11 + 13	
61/831-19	Cushion		11	430x340x80
61/831-20	Backrest		12	730x300x50
61/831-62	Set		13 + 14	
61/831-63	Cushion		13	430x400x70
61/832-21	Backrest		14	500x360x100
<b>Hurlimann</b>				
61/831-3	Cover		15	500x380x280
<b>John Deere</b>				
61/831-10	Set	Séries 20, 30, 40	16 + 17	
61/831-64	Cushion cover		16	420x430x90
61/832-22	Backrest cover		27	670x330x70
61/831-11	Set		18 + 19	
61/831-65	Cushion		18	470x430x70
61/832-23	Backrest		19	





### Cushions et covers (By application)

Ref.		Applications	Fig	Dimensions
<b>Landini</b>				
61/831-29	Cover		1	430x330x330
<b>Massey Ferguson</b>				
61/831-1	Cushion	25, 35, 65, 122, 130, 133, 135, 140, 165, 168, 175, 178, 185, 230, 235, 240, 245, 265, 275, 290, 765, 825, 835, 865	2	470x360x100
61/832-1	Backrest		3	410x40x105
61/831-29	Cover	Serie 200	1	430x330x330
61/831-30	Set			4 + 5 + 6
61/831-31	Cushion		4	450x360x70
61/832-5	Backrest		5	400x30x150
61/832-6	Backrest ext.		6	300x30x150
61/831-32	Cushion vineyard		7	390x450x70
61/831-33	Cover		8	440x400x70
<b>Renault DMA</b>				
<b>Voir Claas</b>				
<b>Same</b>				
61/831-3	Pan cover	Grammer	9	500x380x280
61/831-49	Pan cover	Bostrom	10	450x370x270
61/832-10	Backrest		11	500x320x65
61/832-11	Backrest cover			
61/831-44	Cushion	Sifra Série F	12	440x380x70
61/831-45	Cushion cover			
<b>Sperry New Holland (Clayson)</b>				
61/832-24	Backrest cover		13	400x340x80
61/831-66	Cushion cover		14	470x330x40
<b>Zetor</b>				
61/831-67	Set			15 + 16 + 17
61/831-68	Cushion	4712, 5711, 6711, 6745	15	470x405x65
61/832-25	Backrest		16	450x260x70
61/832-26	Backrest ext.		17	380x170x70
61/831-69	Set	2511, 3511, 4511, 5511	18	600x540x190
61/831-70	Cushion	59115408	19	470x410x70



**BEPCO PARTS SA****HERMALLE-SOUS-HUY**

Rue Chaumont, 4D • 4480 Hermalle-sous-Huy • Belgique  
T +32 85 24 54 00 • F +32 85 24 54 50  
info.be@bepcoparts.com • www.bepcoparts.com

**VILLERS-LE-BOUILLET**

Rue de Waremme, 114 • 4530 Villers-le-Bouillet • Belgique  
T +32 85 24 54 00 • F +32 85 24 54 50  
info.be@bepcoparts.com • www.bepcoparts.com

**BEPCO UK LTD**

Bepco House • Unit 316 • Hartlebury Trading Estate  
Hartlebury - Worcestershire, DY10 4JB (UK)  
P +44 (0)1299 252270 • F 0800 216553  
info@bepcoparts.com • www.bepcoparts.com

**BEPCO FRANCE SAS**

Z.I. La Plaine, Allée de Bigorre  
BP80041 Le Passage • 47901 Agen Cedex 9 • France  
T +33 (0)553 96 31 25 • F +33 (0)553 68 03 72  
info.fr@bepcoparts.com • www.bepcoparts.com

**VILLENEUVE-SUR-LOT**

294 Av. de Bordeaux • CS 30059 Bias  
FR-47302 Villeneuve sur lot • France  
T +33 (0)5 53 40 37 50 • F +33 (0)5 53 70 61 93

**JANZÉ**

P.A. de la Chauvelière • Rue Charles Lindbergh  
35150 JANZE • France  
T + 33 (0)2 99 44 16 18 • F +33 (0)2 99 44 17 29

**TVH AUSTRALASIA PTY LTD**

HEAD OFFICE BRISBANE • www.bepcoparts.com

**ADELAIDE**

96 South Terrace • Wingfield SA 5013  
Free 1800 182 344 • T +61 8 8359 8933 • F +61 8 8234 2212  
BepcoSAsales@tvh.com.au

**BRISBANE**

735 Boundary Road • Richlands QLD 4077  
Free 1800 020 082 • T +61 7 3344 1113 • F +61 7 3344 1332  
BepcoQLDsales@tvh.com.au

**MELBOURNE**

7/66-74 Micro Circuit • Dandenong South VIC 3175  
Free 1800 802 367 • T +61 3 9796 5422 • F +61 3 9796 5251  
BepcoVICsales@tvh.com.au

**PERTH**

2/15 Colin Jamieson Drive • Welshpool WA 6106  
Free 1800 182 344 • T +61 8 8352 8984 • F +61 8 8234 2212  
BepcoWAsales@tvh.com.au

**SYDNEY**

1/1002-1010 Canley Vale Rd • Wetherill Park NSW 2164  
Free 1800 808 827 • T +61 2 6885 5288 • F +61 3 9796 5251  
BepcoNSWsales@tvh.com.au

**TVH NEW ZEALAND LTD****AUCKLAND**

PO Box 51490 • Pakuranga 2140 • 11K Echelon Place  
East Tamaki • Auckland  
Free 0800 459 662 • T +64 9 274 9695 • F +64 9 274 9698  
info@tvh.co.nz • www.tvh.com

**CHRISTCHURCH**

11C Parkhouse Road  
Wigram • Christchurch 8042  
Free 0508 8 722 867 • T +64 3 550 1298 • F +64 3 974 9993  
infochch@tvh.co.nz

**BEPCO DEUTSCHLAND GmbH**

Neuer Weg 5 • 59505 Bad Sassendorf • Germany  
T +49 (0)2927 919 59 0 • F +49 (0)2927 919 59 59  
info.de@bepcoparts.com • www.bepcoparts.com

**BEPCO NEDERLAND BV**

Den Dolvert 10 • 5473 GP, Heeswijk-Dinther • Nederland  
T +31 (0)413 29 39 75 • F +31 (0)413 29 40 87  
info.nl@bepcoparts.com • www.bepcoparts.com

**BEPCO IBÉRICA SA**

Pol. Ind. Les Guixeres, C/ Xarol, 7  
08915 Badalona (Barcelona) • Spain  
T +34 (0)902 111 062 - 933 810 062 • F +34 (0)933 813 345  
info.es@bepcoparts.com • www.bepcoparts.com

**ALMENDRALEJO**

Ctra. Badajoz - Pol. «Rayvaz» Nave 21  
06200 Almendralejo (Badajoz)  
T +34 (0)902 111 062 - 924 664 890  
F +34 (0)924 664 576

**DOS HERMANAS**

Pol. Ind. La Isla, C/ Hornos, 11  
41703 Dos Hermanas (Sevilla)  
T +34 (0)902 111 062 - 954 931 546  
F +34 (0)954 930 130

**SANTIAGO DE COMPOSTELA**

Pol. El Tambre, Via Faraday, 36  
15890 Santiago de Compostela  
T +34 (0)902 111 062 - 981 560 012  
F +34 (0)981 557 753

**TVH PARTS SOUTH AFRICA (Pty) Ltd**

HEAD OFFICE JOHANNESBURG • www.tvh.com

**CAPE TOWN**

1 Karee Street • Kraaifontein Industries • Cape Town 7571  
T +27 21 988 2432 • F +27 21 988 9127  
capetownsales@tvh.com

**DURBAN**

2 Monaco Place • Westmead • Pinetown 3600  
T +27 31 100 0760 • F +27 31 700 6191  
durbansales@tvh.com

**JOHANNESBURG**

90 Electron Avenue • Isando • Kempton Park 1601  
T +27 11 281 27 00 • F +011 974 9845  
johannesburgsales@tvh.com

**LICHTENBURG**

Shop 1 • 109 Scholtz Street • Lichtenburg 2740  
T +27 18 632 6192/6092 • F +27 18 632 6108  
lichtenburgsales@tvh.com

**PORT ELIZABETH**

134 Kempston Road • Korsten • Port Elizabeth 6020  
T +27 41 453 1404/8 • F +27 41 453 1409  
portelizabethsales@tvh.com

## FOR ALL OUR LATEST CATALOGUE UPDATES AND COMPANY INFO: [WWW.BEPCOPARTS.COM](http://WWW.BEPCOPARTS.COM)



The spare parts mentioned in this list can normally be delivered from stock. In addition, we can supply parts, which are not mentioned in this catalogue, with the shortest possible delivery time. The O.E.M. references are only for indication purposes and do not imply that the spare parts are coming from the manufacturer. This spare parts list can be modified without prior notice. All photographs, drawings, illustrations, brand names, descriptions and numbers are included for identification purposes only.



De onderdelen vermeld in deze lijst, zijn normaal uit voorraad leverbaar, behoudens uitverkocht. Ook niet-vermelde onderdelen kunnen binnen de kortste tijd uitgeleverd worden. De O.E.M. referenties dienen enkel ter indicatie en impliceren niet dat deze van de vermelde constructeur afkomstig zijn. Deze onderdelenlijst kan zonder enige voorafgaande verwittiging aangepast worden. Alle gebruikte foto's, tekeningen, afbeeldingen, merknamen, omschrijvingen en nummers dienen alleen ter identificatie.



Les pièces de rechange, mentionnées dans cette liste, sont normalement livrables du stock. En plus, les articles non indiqués peuvent être fournis en peu de temps. Cette liste peut être modifiée sans avis préalable. Les références O.E.M. sont seulement indicatives et n'impliquent pas que les pièces de rechange viennent du constructeur. Toutes les photographies, illustrations, marques, descriptions, tous les plans et numéros servent exclusivement à une identification.



Die in dieser Liste aufgeführten Teile sind normalerweise aus dem Lager lieferbar. Wir sind zudem in der Lage nicht aufgeführte Teile innerhalb kürzester Zeit zu liefern. Die O.E.M. Referenznummern dienen zur Information und beinhalten nicht, dass diese vom genannten Hersteller kommen. Diese Bestandsliste kann ohne vorhergehende Ankündigung geändert werden. Alle verwendeten Foto's, Zeichnungen, Abbildungen, Markennamen, Beschreibungen und Nummern dienen nur zu Identifikationszwecken.



Los artículos mencionados en este catálogo se encuentran habitualmente en stock. Además, podemos suministrar en un plazo corto de tiempo otros artículos relacionados que no se encuentren expresamente mencionados en este catálogo. Las referencias O.E.M. sirven sólo como indicación y no implican que procedan del constructor. Este listado de productos puede estar sujeto a modificaciones sin aviso previo. Todas las fotos, dibujos, ilustraciones, nombres de marca, descripciones y números se han incluido simplemente con el propósito de su identificación.



I pezzi di ricambio, menzionati in questo listino, possono essere forniti con una consegna immediata a condizione che non siano esauriti. I pezzi di ricambio non menzionati possono essere forniti in poco tempo. Le referenze O.E.M. sono solamente indicative e non implicano che i pezzi di ricambio vengano da questo costruttore. Questa lista ricambi può essere agguistata senza avvisi anticipati. Tutti i numeri, codici, nomi, foto, spaccati e disegni sono solo a titolo informativo.



Części z tego katalogu są zazwyczaj na stanie magazynowym. Również części które nie są wyszczególnione w katalogu mogą być dostarczone na zamówienie w najkrótszym możliwym terminie. Opis części O.E.M. jest używany informacyjnie i nie wskazuje na to, że dany produkt jest wyprodukowany przez podanego producenta. Zawartość katalogu może ulec zmianie bez wcześniejszego informowania o tym. Wszystkie użyte zdjęcia, rysunki, nazwy marek, opis i numery służą tylko do identyfikacji.



Запчасти из настоящего списка, как правило, имеются в запасе, если только он не распродан. Прочие, не фигурирующие в списке артикулы, могут быть поставлены в самые кратчайшие сроки. Указание оригинальных номеров производителя не предполагает обязательного оригинального происхождения самих деталей. Данный список может изменяться без предварительного уведомления. Все использованные фото, рисунки, иллюстрации, названия брендов, наименования и номера служат исключительно для цели идентификации.

Visit us on the Internet:  
**[www.bepcoparts.com](http://www.bepcoparts.com)**

© **bepco** 2015

All rights reserved. No part of this catalogue may be reproduced or communicated in any form or by any means, electronic or mechanical, including copying, recording or use in an information storage or retrieval system, without prior and explicit permission of BEPCO PARTS.

- BEPCO is a supplier of after-market spare parts and accessories that are suitable for the maintenance and repair of OEM-equipment. OEM references and brands are purely indicative and do not imply that the accessories and/or spare parts are coming from the original equipment or parts manufacturer.
- Products that do not comply with regulatory requirements concerning CE conformity are not placed on the market in the European Economic Area.
- BEPCO® are registered trademarks.
- All sales are subject to the general terms & conditions of sale on [www.bepcoparts.com](http://www.bepcoparts.com)
- Photographs and illustrations are included for reference purposes only. Printing errors reserved.

**Spare parts**  
from A-Z for  
**all brands**

Case IH  
David Brown  
Fendt  
Fiat  
Ford  
Hürlimann  
JCB  
John Deere  
K.H.D. (Deutz)  
Kubota  
Landini  
Lamborghini  
Manitou  
Massey Ferguson  
Mc Cormick  
Merlo  
New Holland  
Renault  
Same  
Steyr  
Valmet  
Zetor

*moving forward in every field*

REF. 90/999-238



**HEAD OFFICE**

Rue Chaumont 4D • 4480 Hermalle-sous-Huy • Belgium  
T +32 (0)85 24 54 00 • F +32 (0)800 23 132 • info.be@bepcoparts.com • www.bepcoparts.com

Member of **TVH** 